

Systeme für Aquakultur,
Aquaristik, Labore und
zur Wasseraufbereitung

Systems for aqua culture,
sea water aquaria, labs and
water desalination and purification

Systèmes pour aquacultur,
aquariums eau de mer,
laboratoires et traitements d'eau



AquaCare GmbH & Co. KG
Am Wiesenbusch 11
D-45966 Gladbeck
Tel.: +49-2043-375758-0
Fax: +49-2043-375758-90
<http://www.aquacare.de>
e-mail: info@aquacare.de

Leerfilter 300 / Empty Filter 300/ Filtre Vide 300 / Filtro Vuoto 300 / Filtr Pusty 300

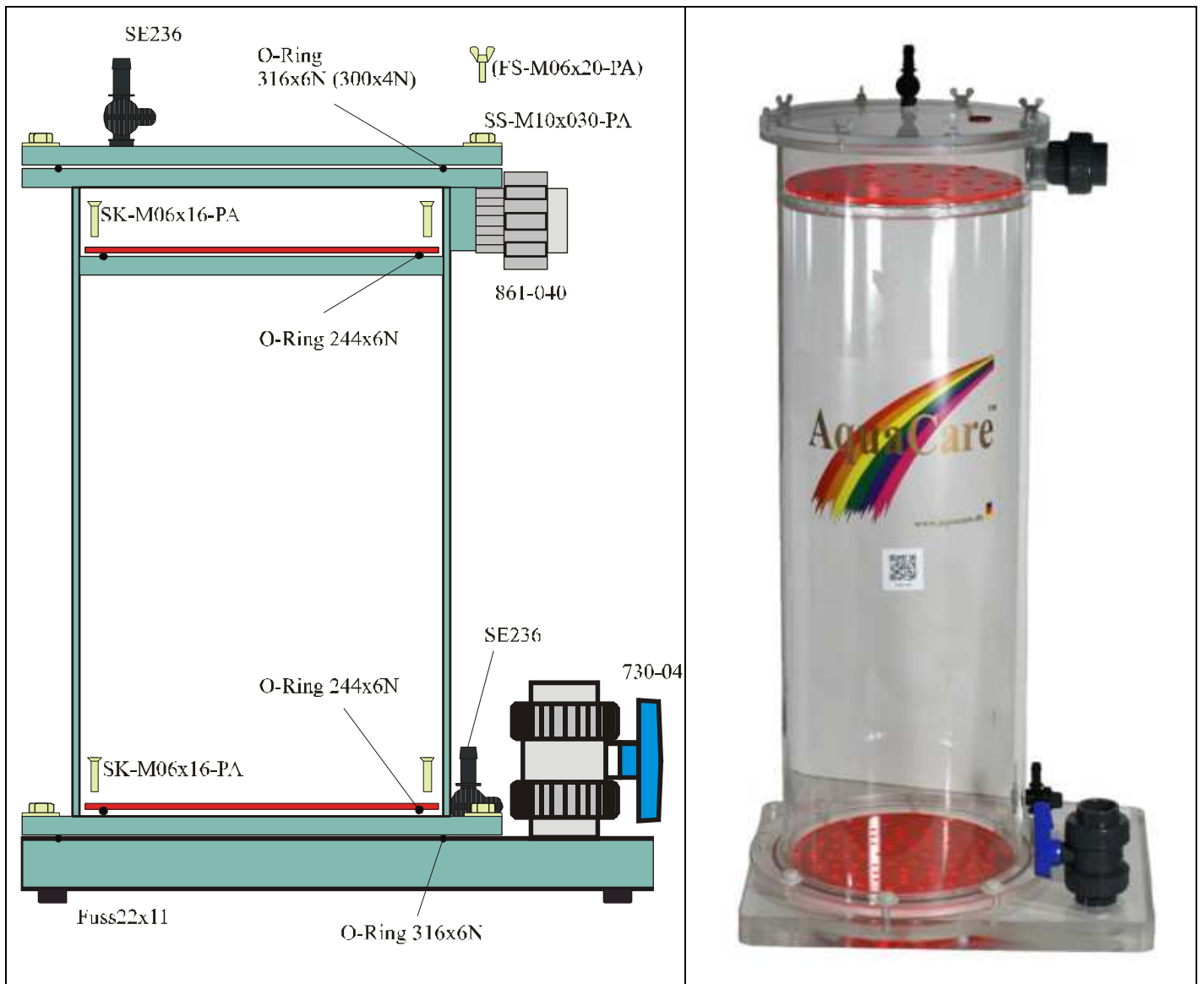

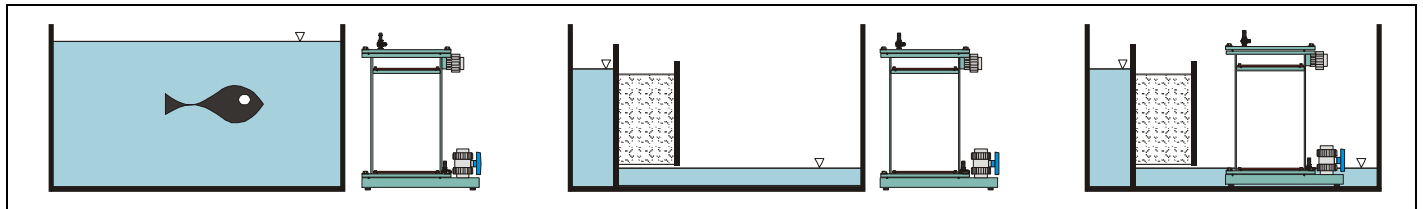

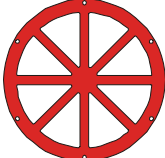

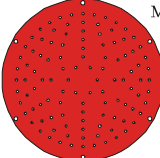
 MF2-300-6µm
 MF2-300-15µm
 MF2-300-25µm
 MF2-300-50µm
 MF2-300-100µm
 MF2-300-150µm
 MF2-300-200µm
 MF2-300-2mm

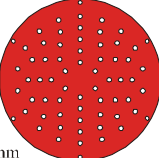
 MF2-300-4mm

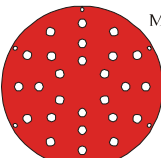
 MF2-300-8mm

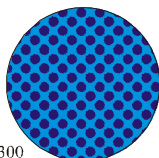
 MF2-300-15mm

 schwamm300

 Con20x1.5-12mm

www.aquacare-shop.de

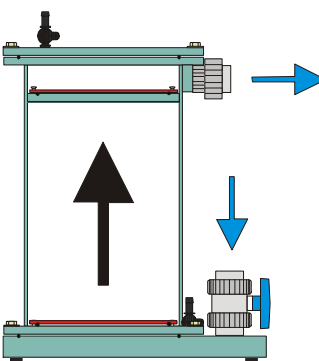
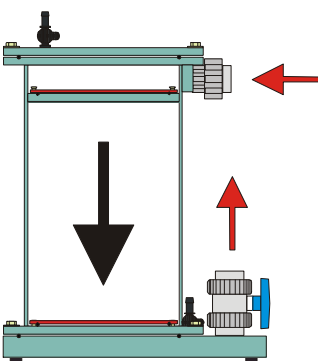
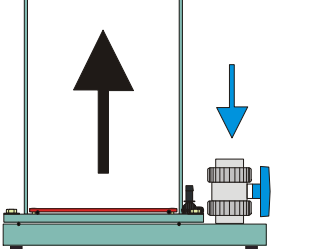
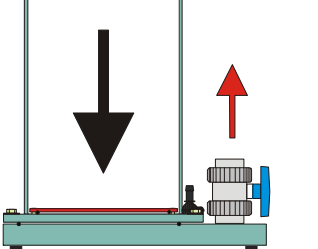
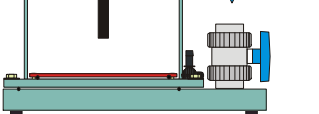
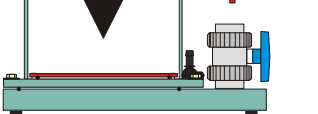
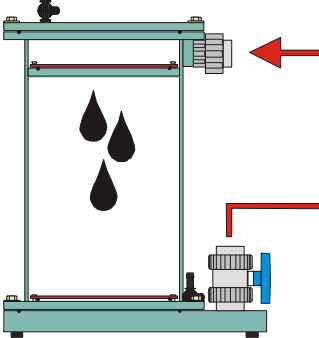
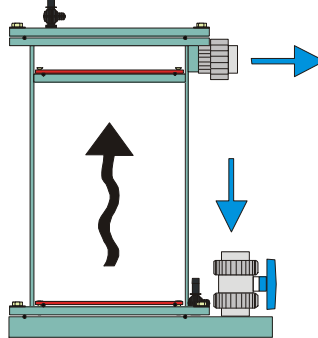
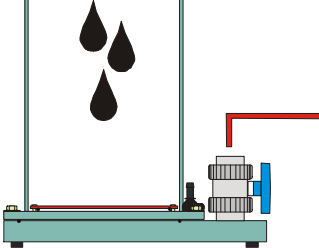
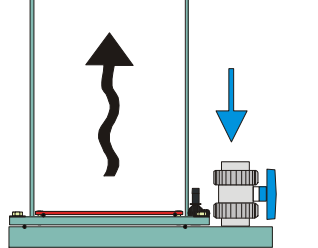
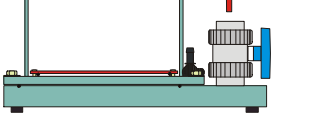
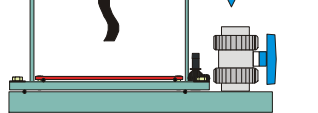
	upstream		downstream
MF2-300-6µm ... MF2-300-2mm			
MF2-300-4mm ... MF2-300-15mm			
schwamm300			
	trickling		moving bed
MF2-300-6µm ... MF2-300-2mm			
MF2-300-4mm ... MF2-300-15mm			
schwamm300			









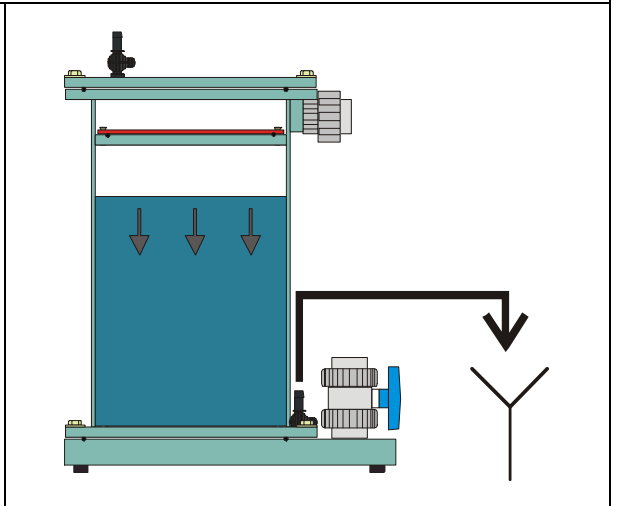
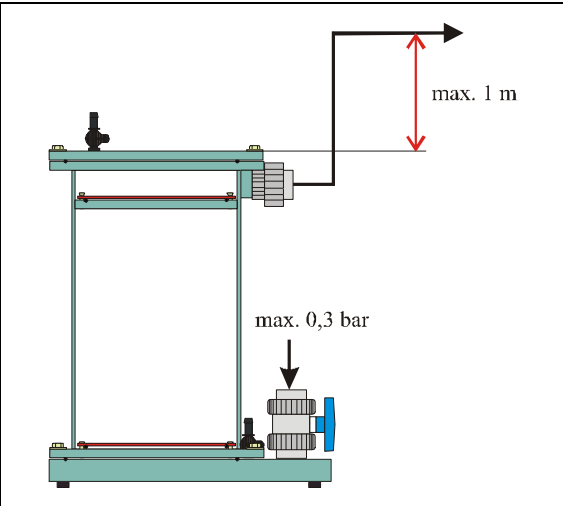





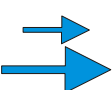











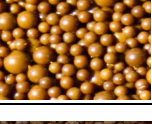

































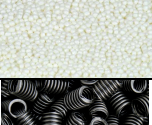



 max. 2 Nm











Filtermaterial Filter Material Matériau de filtration Materiale filtrante Materiał filtracyjny		Up- stream	Down- stream	Moving Bed	Trickling	Flow	Time
							
	Aktivkohle Activated carbon Charbon actif Carbone attivo Węgiel aktywny					< 3,7 m ³ /h	15...60 d
	Zeolith Zeolite					< 3,7 m ³ /h	360 d
	Phosphat-X-Globuli					0,8...1,2 m ³ /h	 PO ₄
	Phosphatadsorber Phosphate adsorber Adsorbeur de phosphate Adsorbente di fosfato fosforan adsorbera					0,3...0,5 m ³ /h	 PO ₄
	Quarzsand 0,8 mm Quartz sand 0.8 mm Sable de quartz 0,8 mm Sabbia di quarzo 0,8 mm Piasek kwarcowy 0,8 mm					2,8...3,4 m ³ /h	
	Kalzium Calcium Calcio Wapń					< 4,6 m ³ /h	
	AquaCare +Globuli					< 1,0 m ³ /h	
	Schwefel / Sulfur Soufre Zolfo Siarki					< 2,8 m ³ /h	
	POC+Globuli					< 1,0 m ³ /h	
	Biobälle / Bio balls Balles organiques Sfere organiche Bale organiczne					< 7,2 m ³ /h	

Technische Daten, Technical Data, Données techniques, Dati tecnici, Dane techniczne					
DE	EN	FR	IT	PL	
Bestellnummer	Order number	Numéro de commande	Numero d'ordine	Numer zamówienia	370-299/ -300/ -301
Gesamthöhe	Total height	Hauteur totale	Altezza totale	Wysokość całkowita	50/100/150 cm
Benötigte Höhe	Minimum Space	Hauteur requise	Altezza richiesta	Wysokość	+5 cm
Grundfläche	Footprint size	Empreinte de pas	Impronta	Ślad	50×38 cm
Durchmesser	Diameter	Diamètre	Diametro	Średnica	300 mm
Material	Material	Matériel	Materiale	Materiał	PMMA, NBR
Anschlüsse	Connectors	Connexions	Connessioni	Połączenia	d40
Masse	Weight	Poids	Peso	Waga	13, 16, 19 kg
Maximaler Zulaufdruck	Maximum inlet pressure	pression d'entrée maximale	pressione in ingresso massima	Maksymalne ciśnienie wlotowe	0,3 bar



	Aktivkohle, Activated carbon, Charbon actif, Carbone attivo, Węgiel aktywny		
 DE	http://aquacare.de/index.php/anlagenbau/anlagenbau-info/aktivkohle-einsatzgebiete.html	http://aquacare.de/index.php/en/plant-construction/plant-construction-info/activated-carbon-field-of-application.html	 EN
	Phosphat-X-Globuli, Phosphatadsorber, Phosphate adsorber, Adsorbeur de phosphate, Adsorbente di fosfato, fosforan adsorbera		
 DE	http://aquacare.de/index.php/aquaristik/aquaristik-info/tipps-tricks/41-wasserchemie/221-phosphat-meerwasseraquarium.html	http://aquacare.de/index.php/en/aquaristic/aquaristic-info/hints-tricks/50-water-chemistry-physics/270-phosphate-sea-water.html	 EN
	Kalzium, Calcium, Calcio, Wapń		
 DE	http://aquacare.de/index.php/aquaristik/aquaristik-info/tipps-tricks/41-wasserchemie/217-methoden-kalkwasser.html	http://aquacare.de/index.php/en/aquaristic/aquaristic-info/hints-tricks/50-water-chemistry-physics/268-methods-lime-water.html	 EN
 DE	http://aquacare.de/index.php/aquaristik/aquaristik-info/tipps-tricks/41-wasserchemie/137-haerte-uebersicht.html	http://aquacare.de/index.php/en/aquaristic/aquaristic-info/hints-tricks/50-water-chemistry-physics/250-hardness-overview.html	 EN
 DE	http://aquacare.de/index.php/aquaristik/aquaristik-info/tipps-tricks/41-wasserchemie/138-methoden-haerte.html	http://aquacare.de/index.php/en/aquaristic/aquaristic-info/hints-tricks/50-water-chemistry-physics/254-methods-hardness.html	 EN
	Schwefel, Sulfur, Soufre, Zolfo , Siarki		
 DE	http://aquacare.de/index.php/aquaristik/aquaristik-info/tipps-tricks/41-wasserchemie/220-nitrat-kalkstufe.html	http://aquacare.de/index.php/en/aquaristic/aquaristic-info/hints-tricks/50-water-chemistry-physics/271-nitrate-filter-with-chalk-stage.html	 EN
 DE	http://aquacare.de/index.php/anlagenbau/anlagenbau-info/denitrifikation-methoden.html		
 DE	http://aquacare.de/index.php/aquaristik/aquaristik-info/tipps-tricks/41-wasserchemie/219-nitrat-muss-ein-filter-her.html	http://aquacare.de/index.php/en/aquaristic/aquaristic-info/hints-tricks/50-water-chemistry-physics/256-nitrate-filter-requirement.html	 EN